

2007 Vol, 1

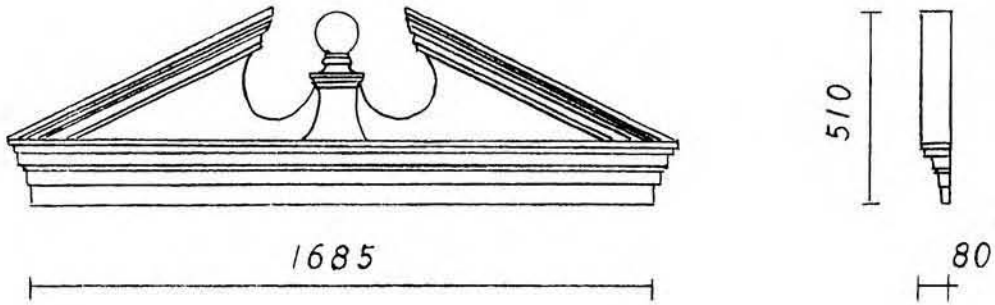

Ante-PS 1685



Ante-PS 1400 (\*\*FRP)

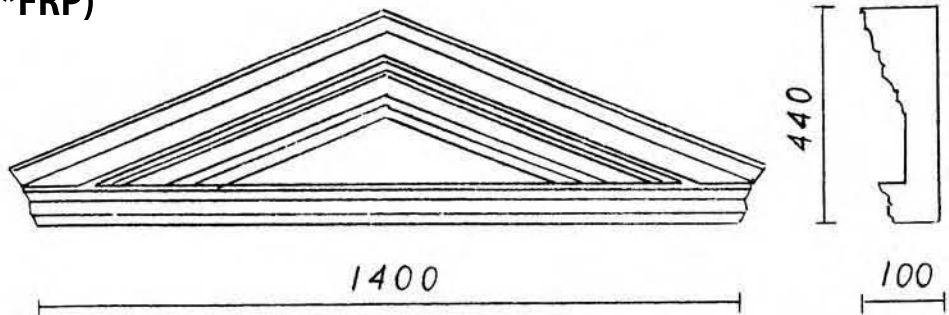

Ante-PS 1284

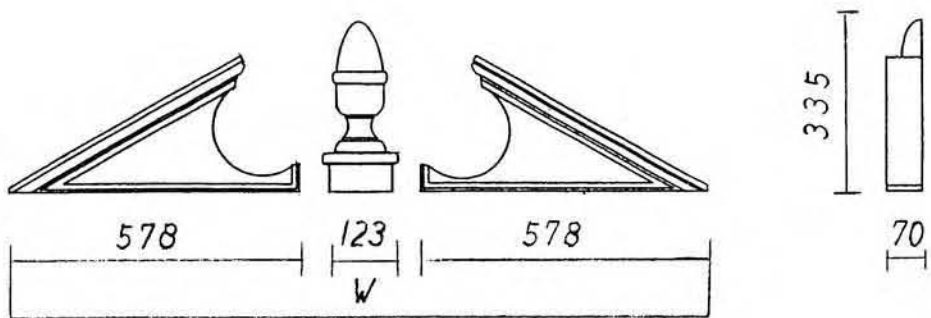

※Ante-PS 1284 は3分割になっているため、W寸法調整が可能です。

また、モールディングと組み合わせが可能です。

例) モールディング Ante-MS 135-75 との組み合わせ

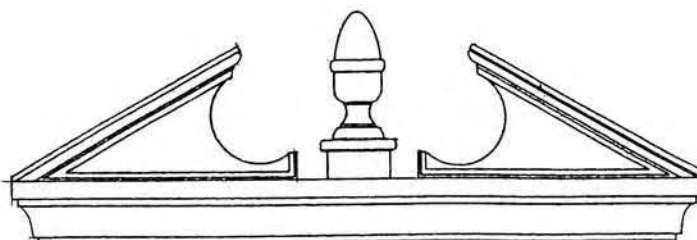

# Cross Heads

## Window Heads

Polyurethane

### Ante-CHS 200-95

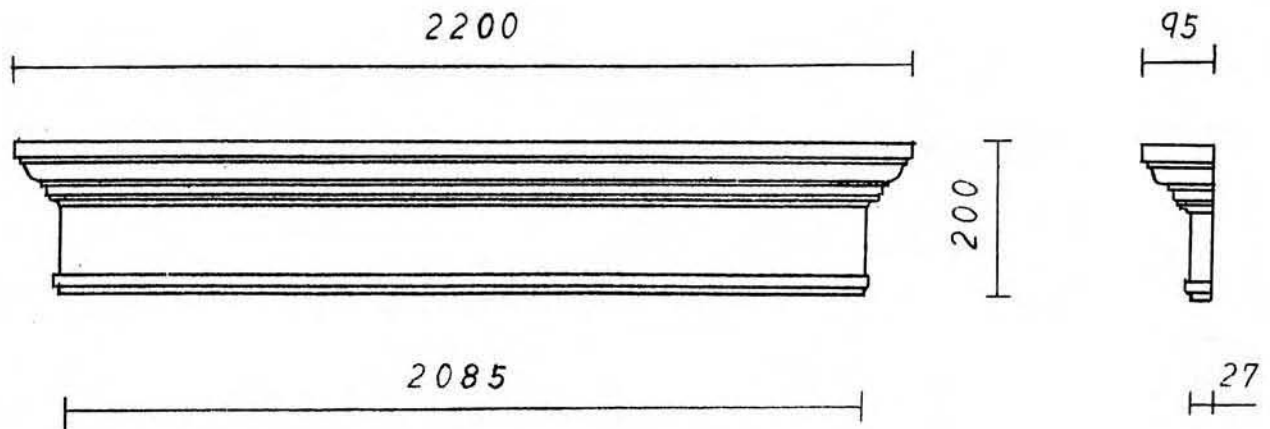

◇専用キーストン Ante-KSS200-95

### Ante-WHS 150-72

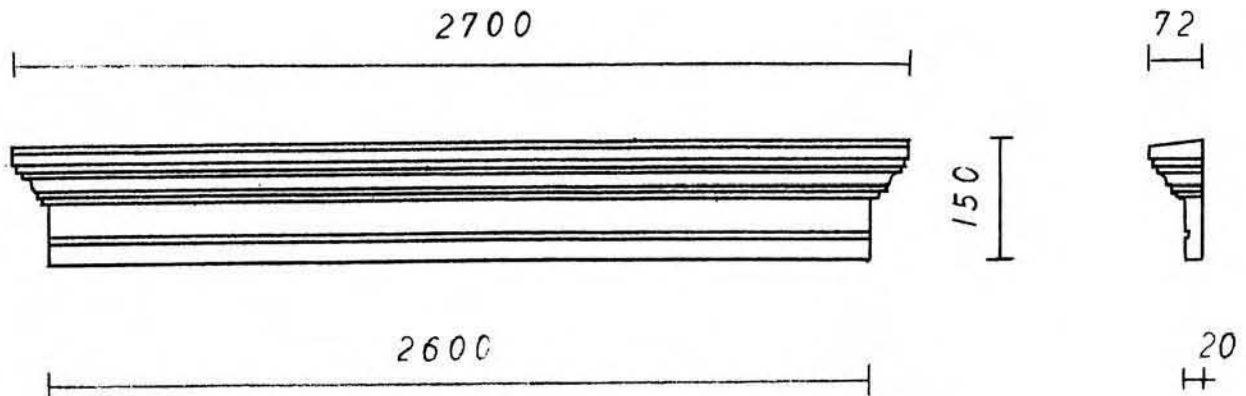

◇専用キーストン Ante-KSS150-72

### Ante-WHS 143-70 (Type 10, Type 19)

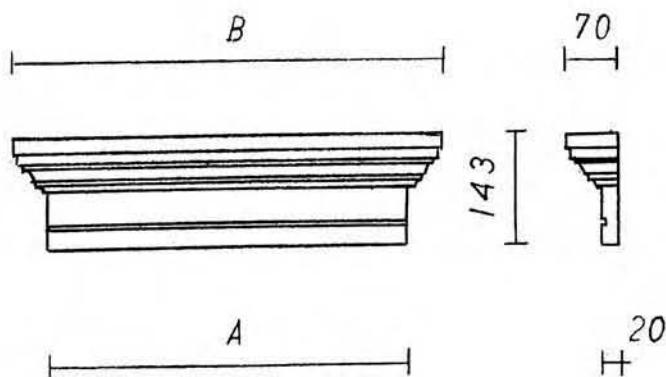

Type 10 A = 1005

B = 1105

Type 19 A = 1900

B = 2000

◇専用キーストン Ante-KSS150-72

※各種 寸法調整加工承ります。

# Sunbursts

Polyurethane

Ante-SS 775-230

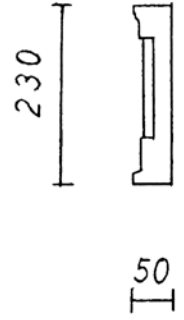
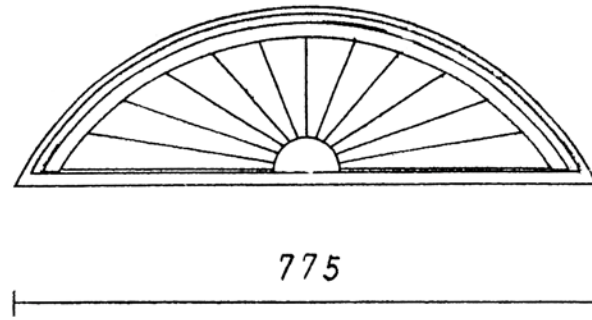

Ante-SS 910-230

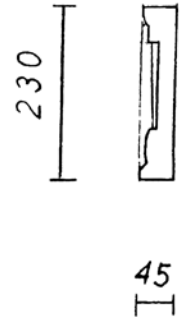
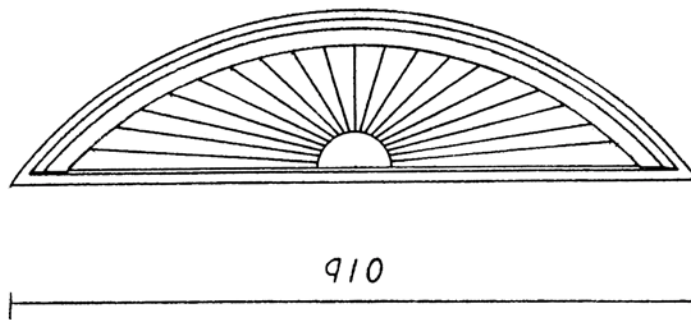

Ante-SS 920-250

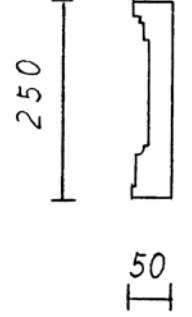
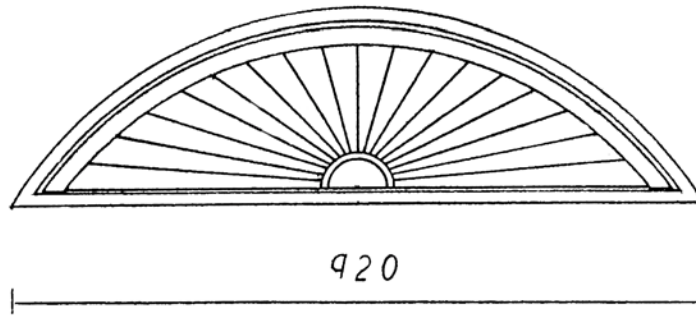

Ante-SS 1415-320

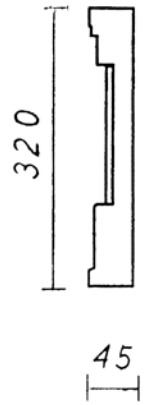
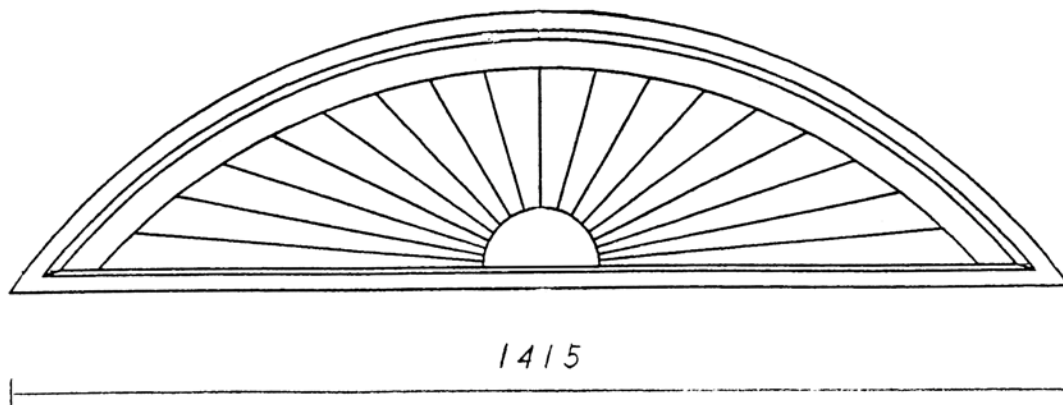

※各種 寸法調整加工承ります。

Ante-WHS 640-255

Ante-WHS 900-280

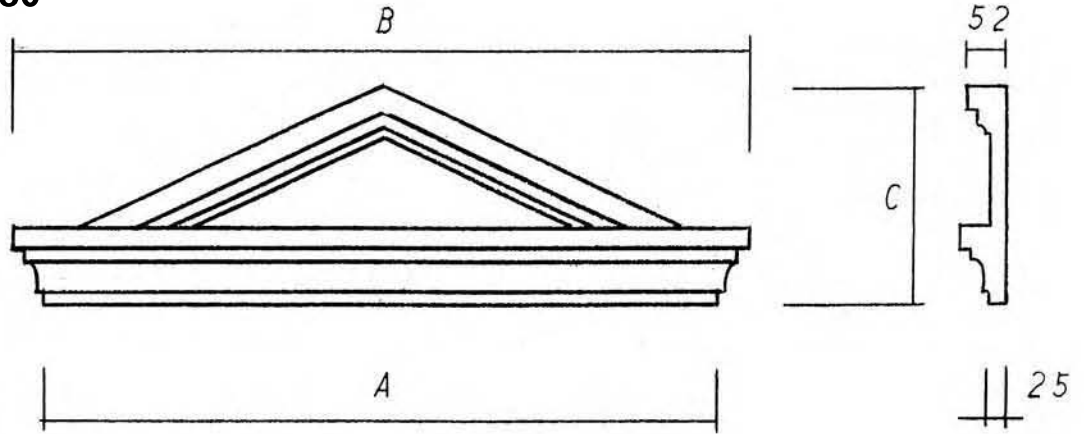

	A	B	C
Ante-WHS 640-255	640	690	255
Ante-WHS 900-280	900	980	280

Ante-WHS 2000-200

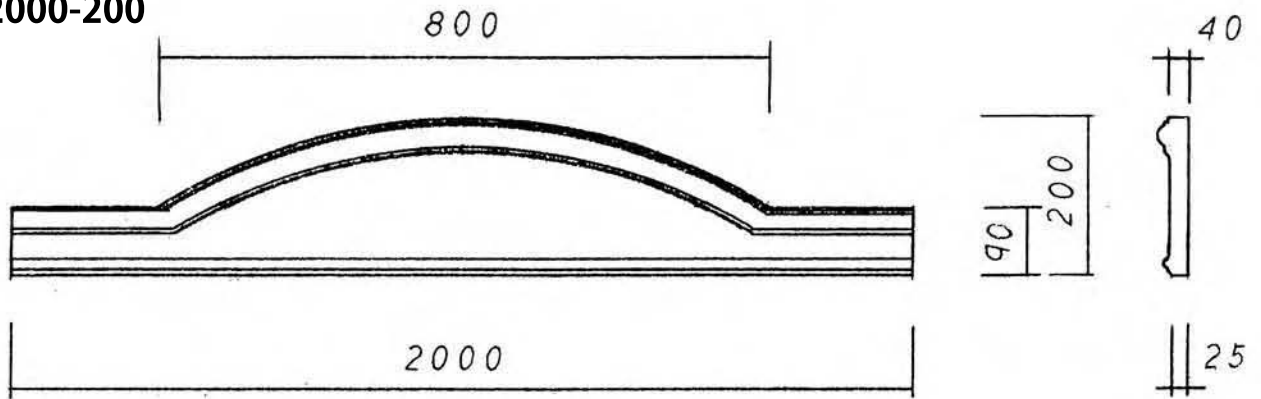

※モールディング Ante-MS 90-40 と組み合わせが可能です。

例) モールディング Ante-MS 90-40 との組み合わせ

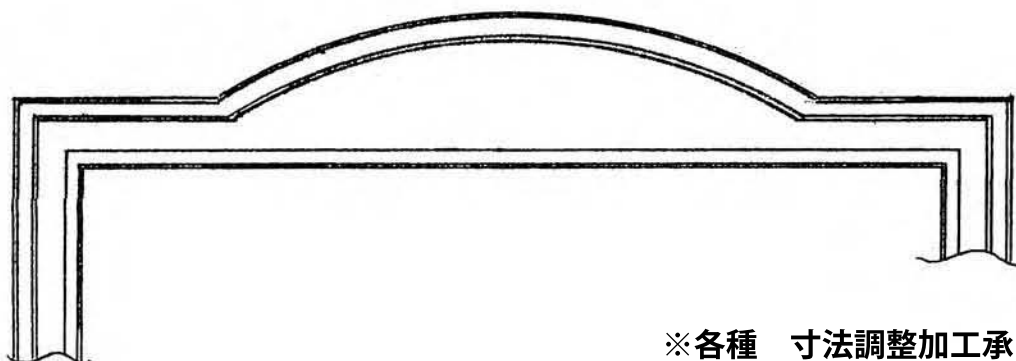

※各種 寸法調整加工承ります。

Ante-WHS 135-75

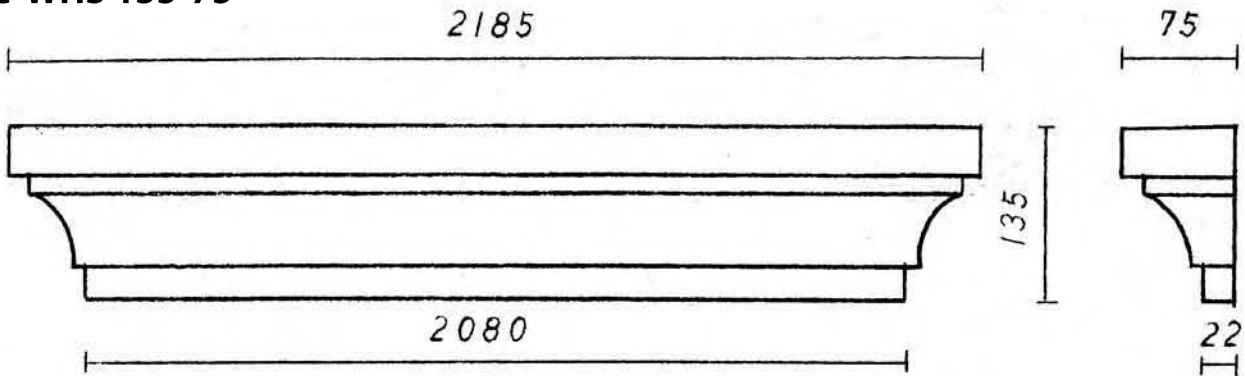

◇専用キーストン Ante-KSS 135-75 A / Ante-KSS 135-75 B

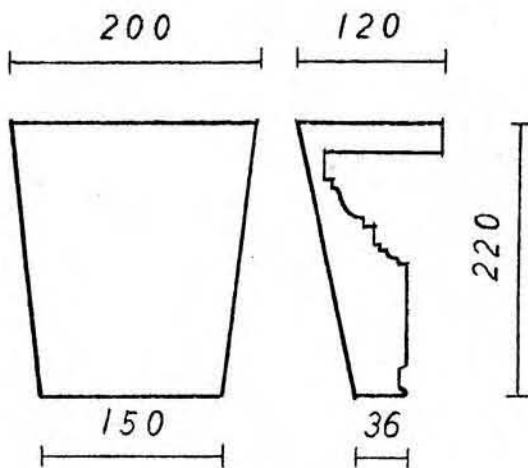

Ante-KSS 200-95

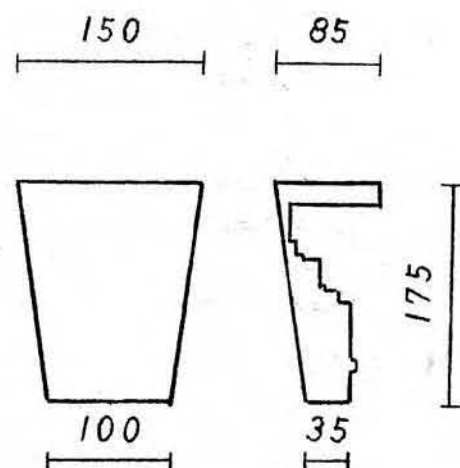

Ante-KSS 150-72

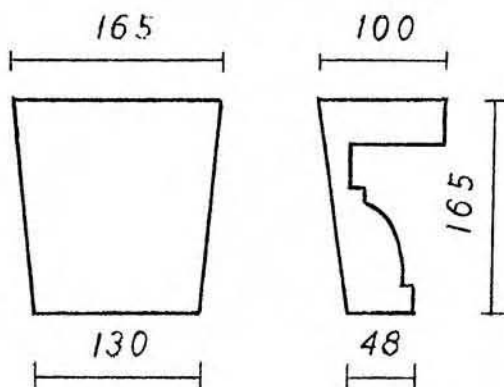

Ante-KSS 135-75 A

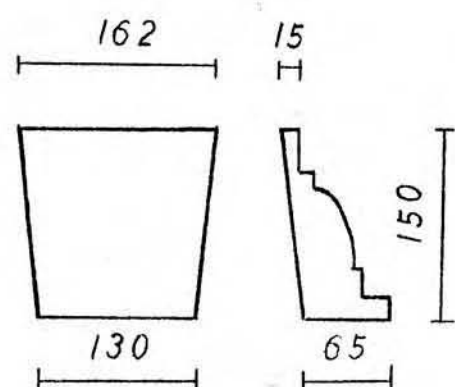

Ante-KSS 135-75 B

※各種 寸法調整加工承ります。

Ante-RLS 450

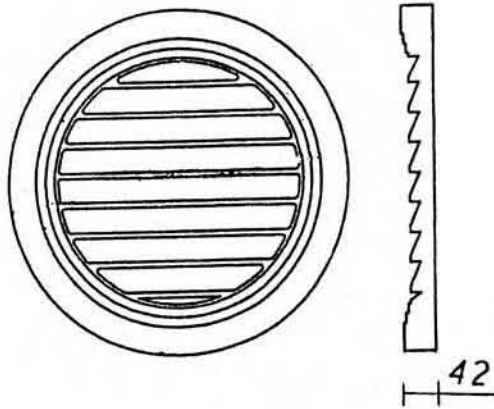

Ante-RLS 450K w/ Keystone

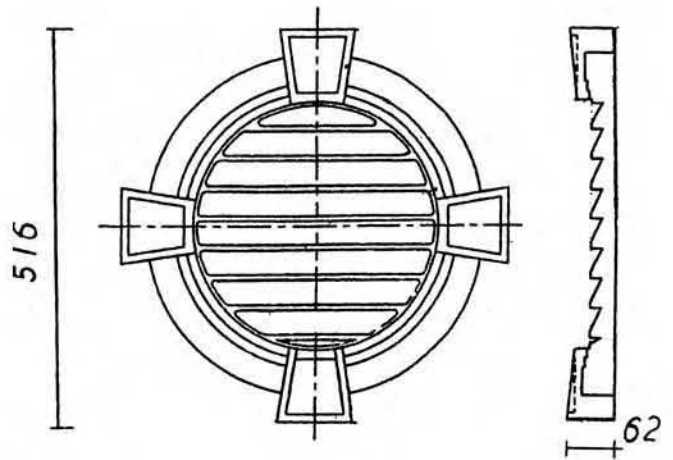

Ante-RLS 600

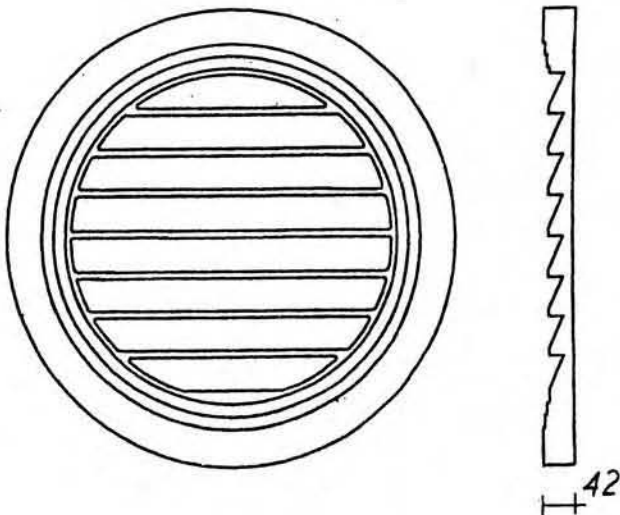

Ante-RLS 600 K w/ Keystone

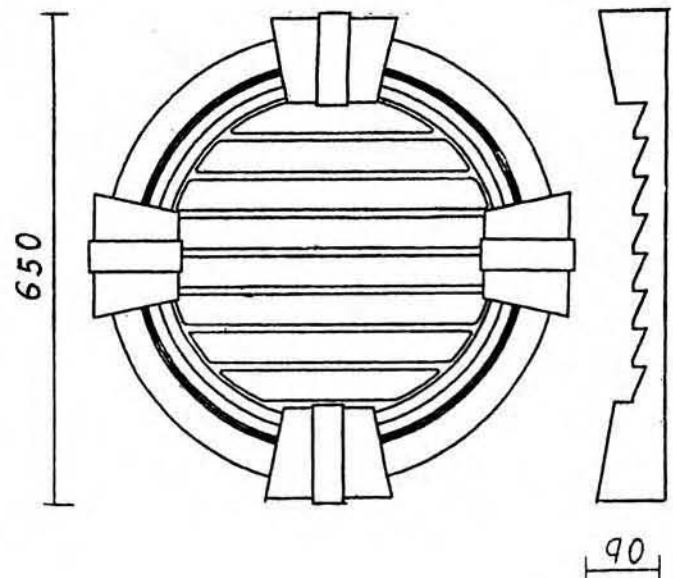

Ante-RLS 600

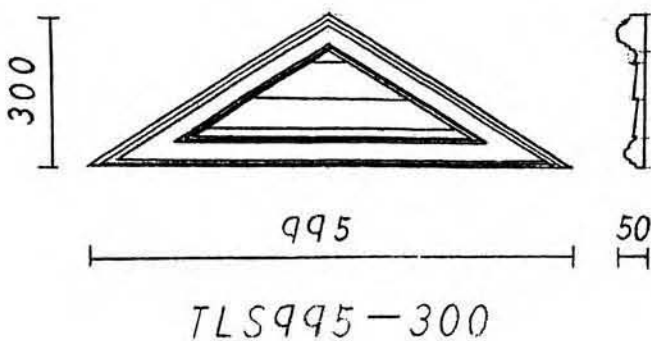

Ante-RLS 600 K

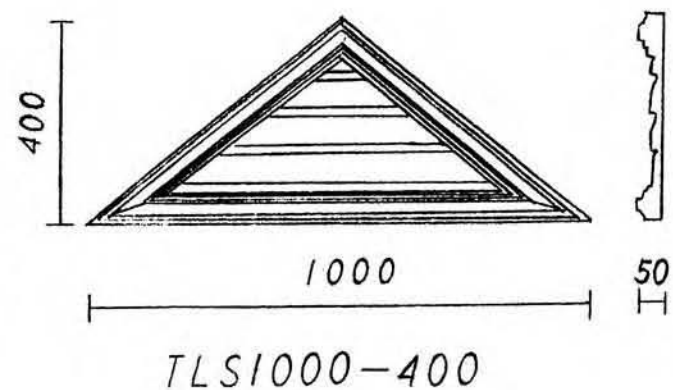

※各種 寸法調整加工承ります。

Ante-PLS 800-400

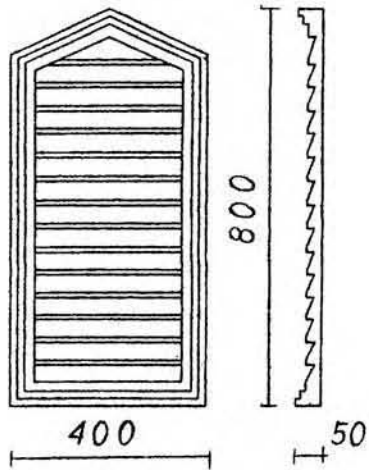

Ante-HLS 900-450

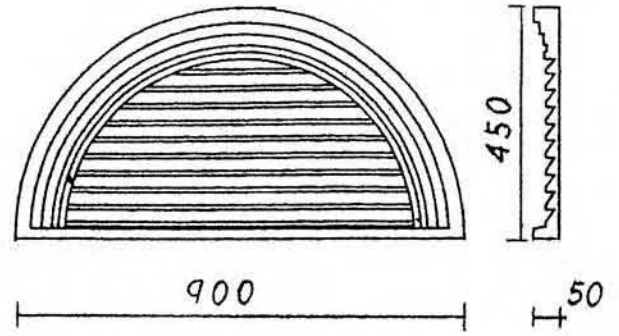

Ante-PLS 1400-400

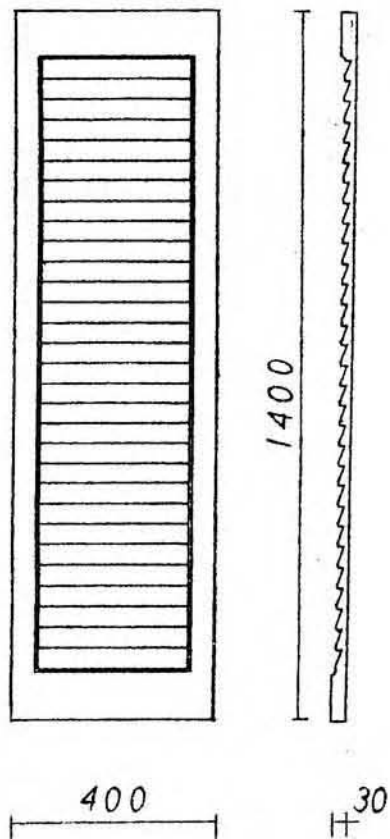

Ante-HLS 1400-500

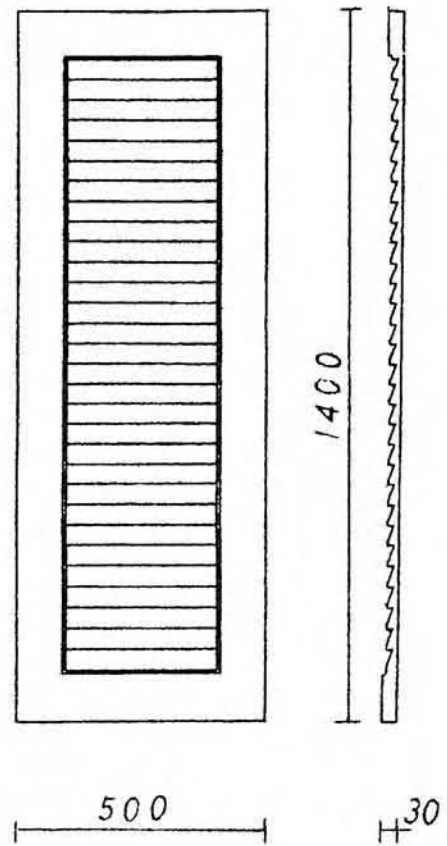

※各種 寸法調整加工承ります。



# Window Pillars

Polyurethane

Ante-PIS 125    Ante-PIS 160    Ante-PIS 180 P    Ante-PIS 180 F    Ante-PIS 180FL

125

160

180

180

180

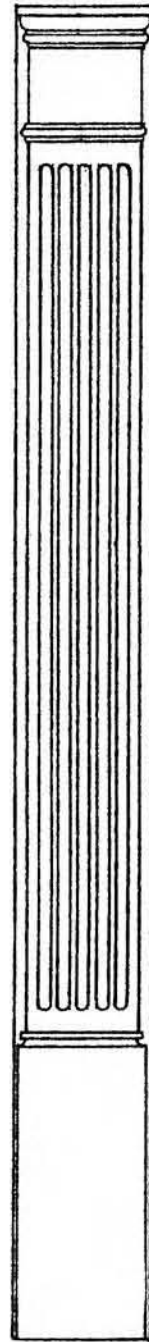
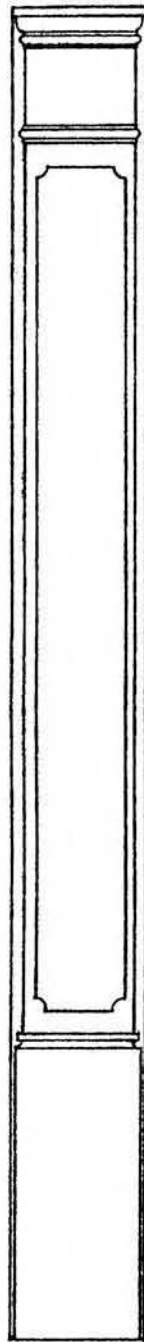

L=2720

L=2270

L=2570

L=2570

L=2800

※各種 寸法調整加工承ります。

Ante-HRS 150 (\*\*FRP)

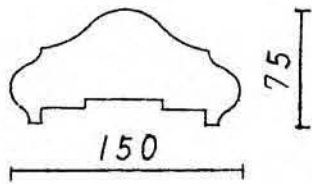

Ante-HRS 200 (\*\*FRP)

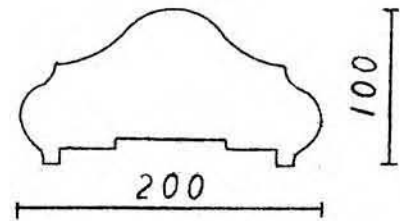

Ante-BAS 01 (\*\*FRP)

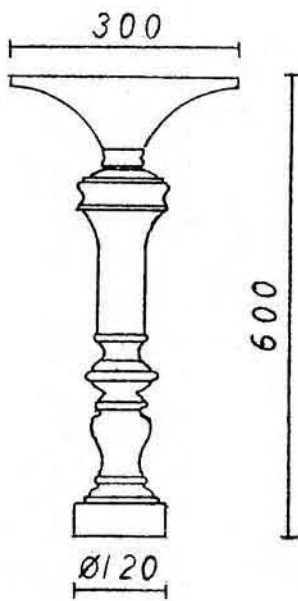

Ante-BAS 02 (\*\*FRP)

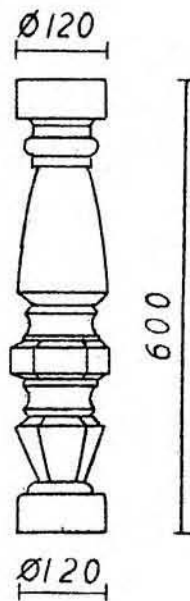

Ante-BAS 03 (\*\*FRP)

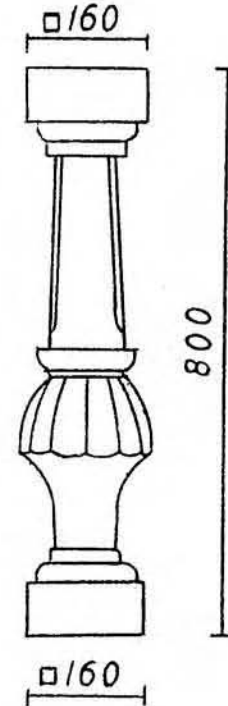

Ante-BAS 04 (\*\*ABS)

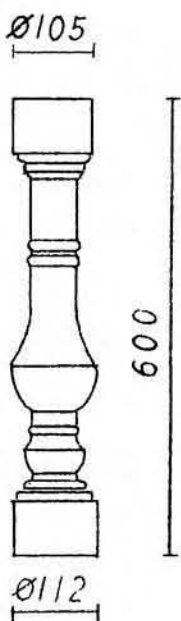

Ante-BAS 05 (\*\*ABS)

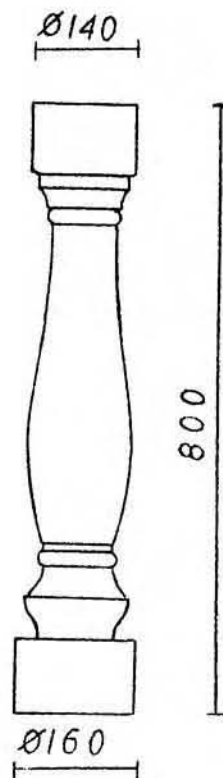

※ Ante-BAS 03 及び Ante-BAS 05 は  
Ante-HRS 150 に使用出来ません。

※各種 寸法調整加工承ります。

Ante-PS 00 (\*\*FRP)

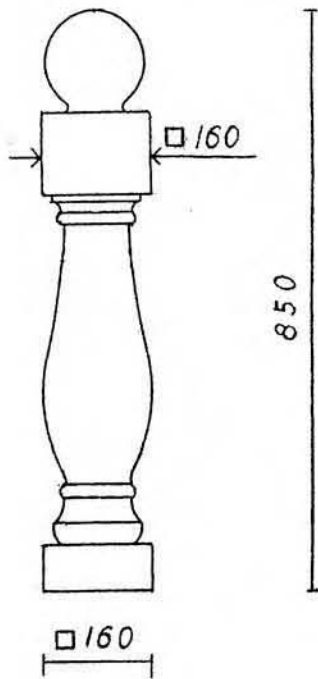

Ante-PS 01 (\*\*FRP)

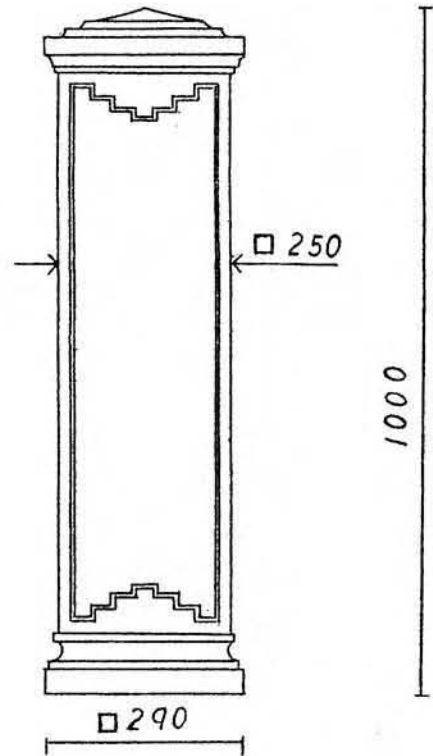

Ante-PS 02 (\*\*FRP)

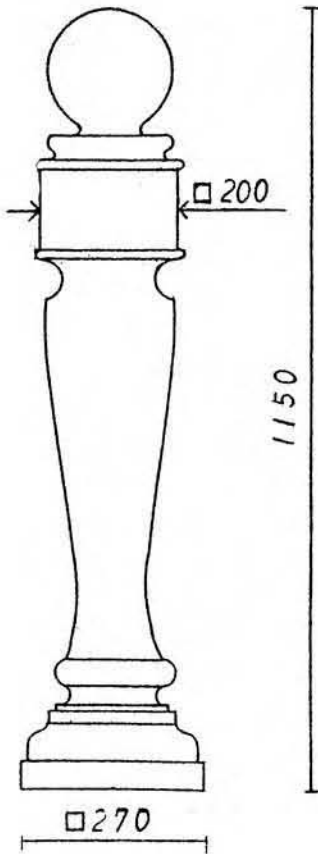

Ante-PS 03 (\*\*FRP)

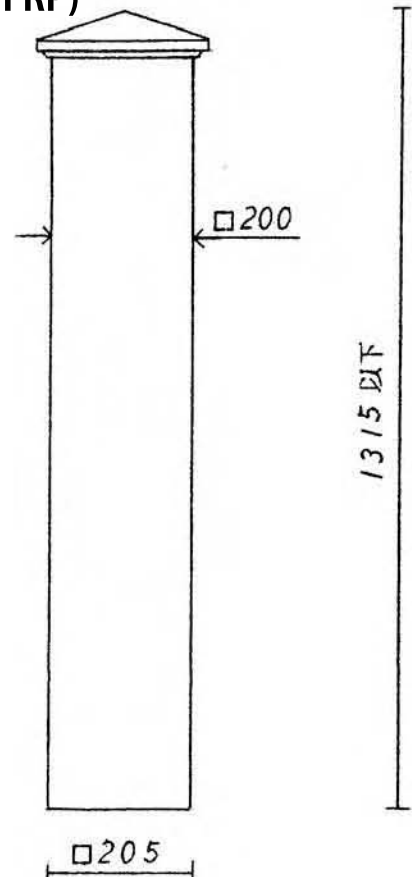

※各種 寸法調整加工承ります。

Ante-QS 1000-400

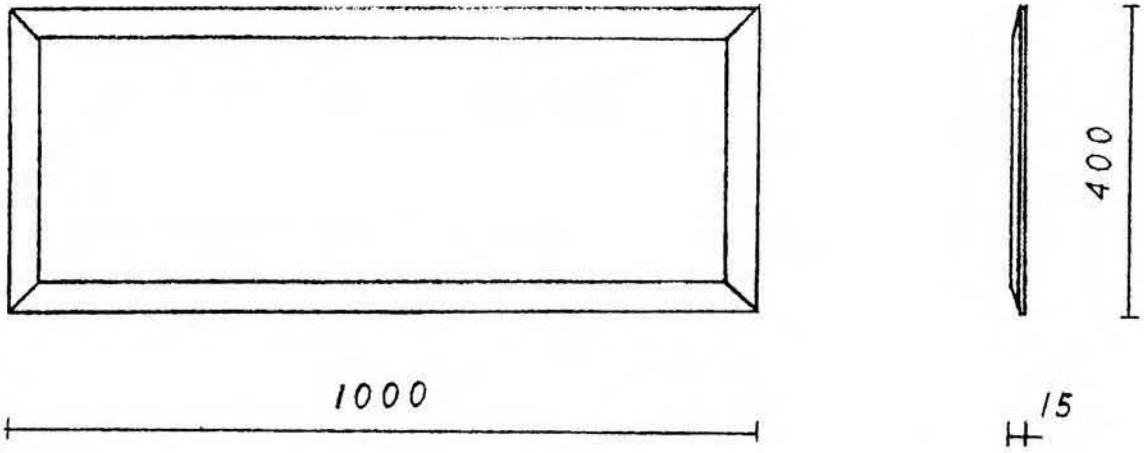

Ante-QS 1040-250

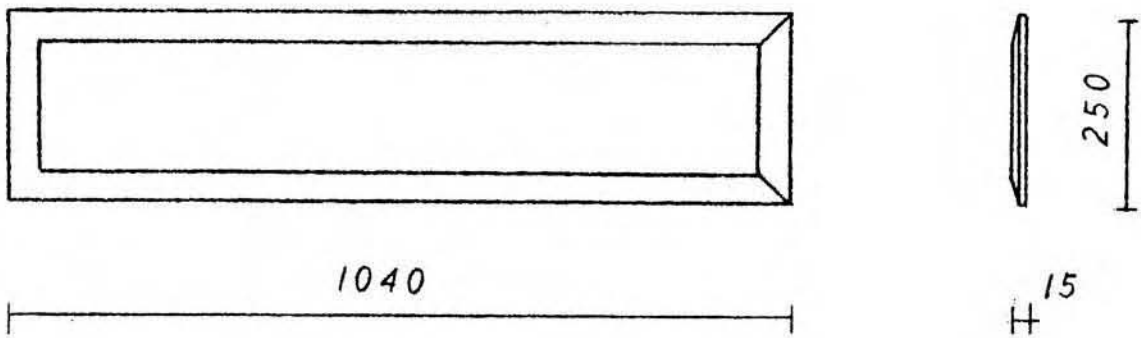

Ante-QS 2045-408

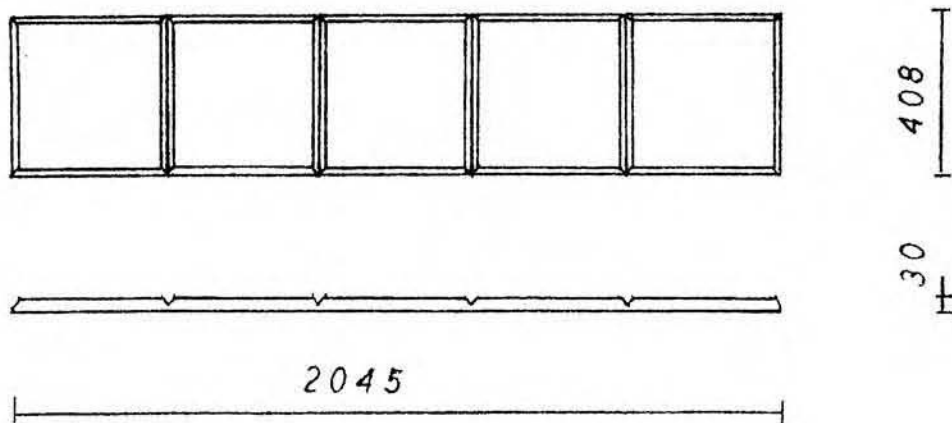

※各種 寸法調整加工承ります。

Ante-CBS 75-50 / 120-75 / 130-150 / 160-100 / 165-200 / 265-300

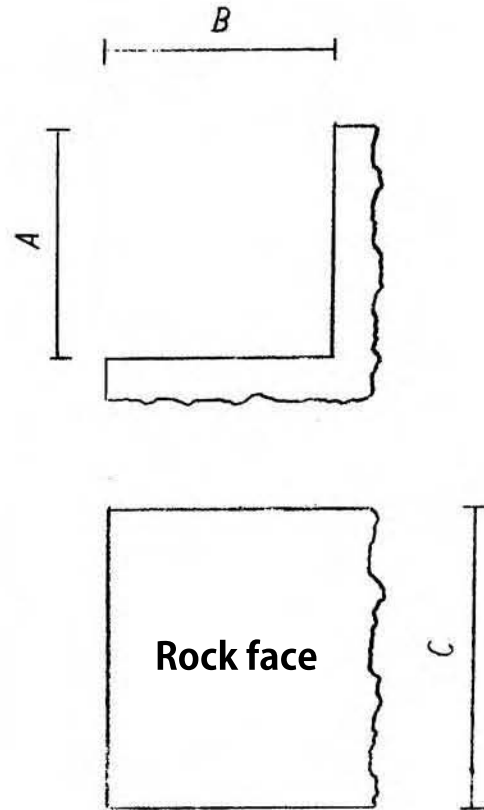
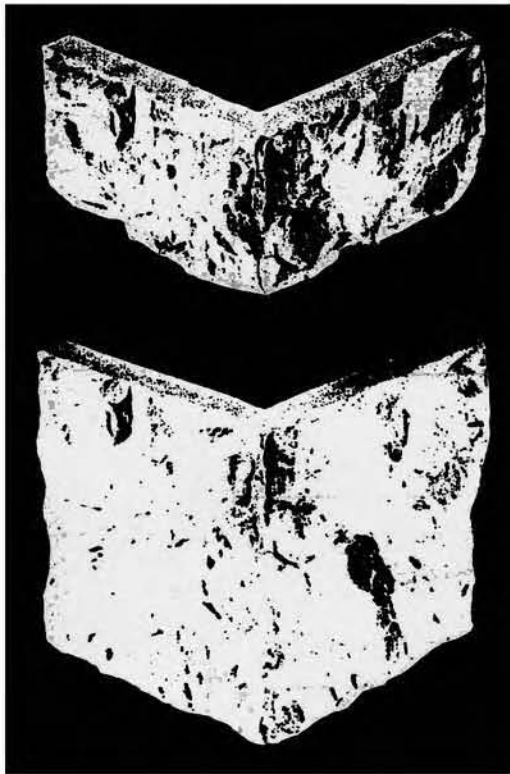

	A	B	C
Ante-CBS 75- 50	75	75	50
Ante-CBS 120- 75	120	120	75
Ante-CBS 130-150	130	130	150
Ante-CBS 160-100	160	160	100
Ante-CBS 165-200	165	165	200
Ante-CBS 265-300	265	265	300

※平均肉厚 30 mm

※各種 寸法調整加工承ります。

**Ante-MS-F 745-515 (\*\*FRP)**

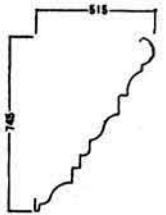
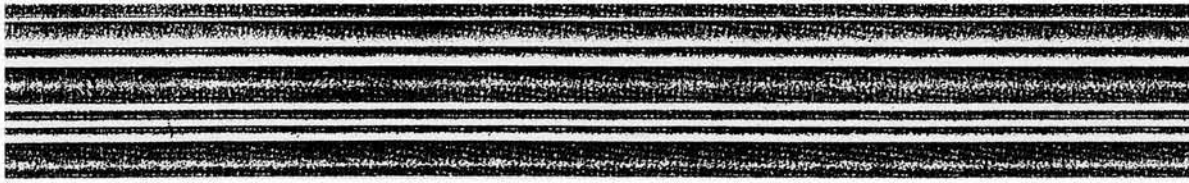

**Ante-MS-F 540-220 (\*\*FRP)**

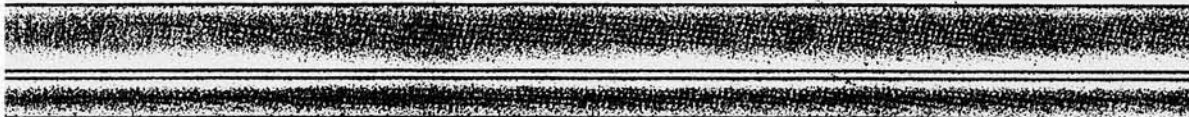

**Ante-MS-F 450-340 (\*\*FRP)**



**Ante-MS-F 450-150 (\*\*FRP)**



**Ante-MS-F 300-250 (\*\*FRP)**



**Ante-MS-F 300-240 D (\*\*FRP)**



**Ante-MS-F 200-160 (\*\*FRP)**

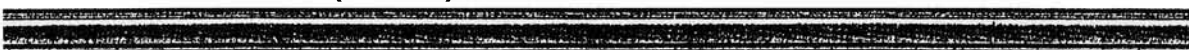

**Ante-MS-P 200-160 K (\*\*PUF=PolyUrethaneForm)**

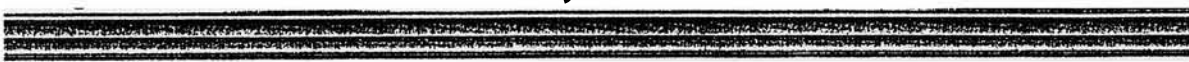

**Ante-MS-P 120-112 D (\*\*PUF)**

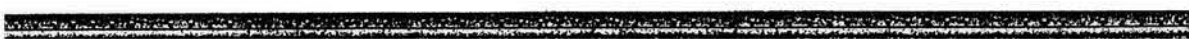

**Ante-MS-P 100-72 (\*\*PUF)**



**Ante-MS-P 80-70 D (\*\*PUF)**



このページの商品定尺は全てL=2000となっております。※各種 寸法調整加工承ります。

Ante-MS-F 200-190(\*\*FRP)

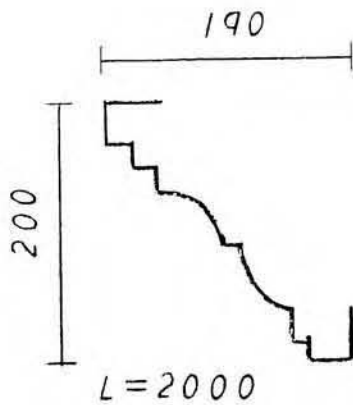

Ante-MS-F 300-100(\*\*FRP)

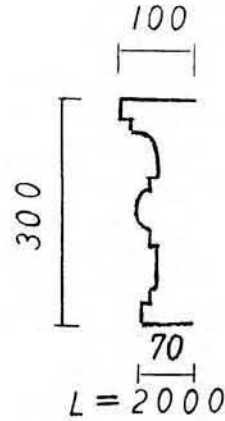

Ante-MS-F 325-150(\*\*FRP)

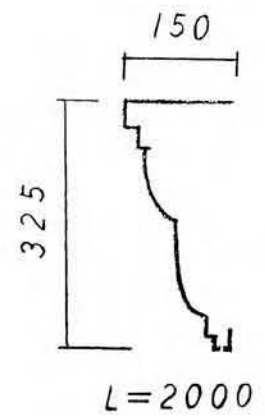

Ante-MS-F 345-75(\*\*FRP)

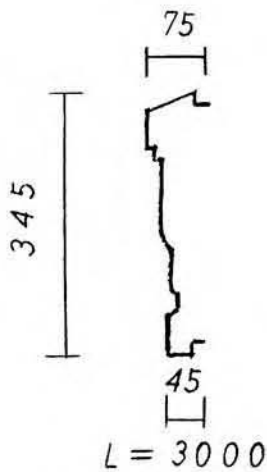

Ante-MS-F 370-350(\*\*FRP)

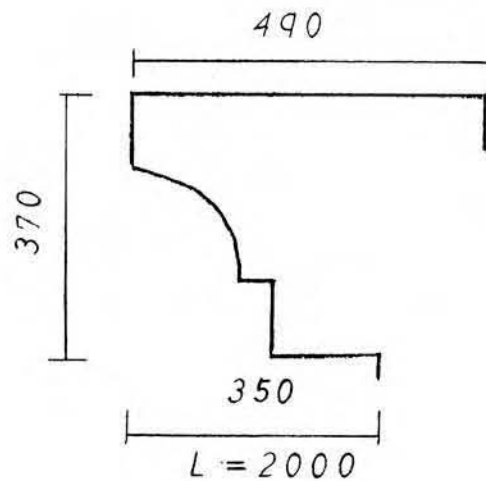

Ante-MS-F 750-500(\*\*FRP)

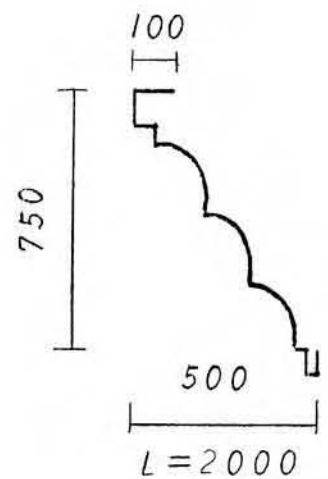

Ante-MS-F 800-545 / 500-350 (\*\*FRP)

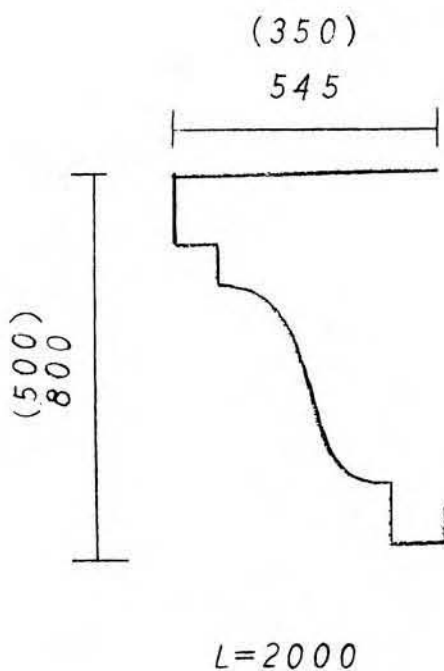

※天板延長加工、出隅入隅コーナー加工、  
各種 寸法調整加工承ります。

※内外R曲面、特注商品製作致します。

上記以外にも多数御座います。

御問い合わせお願い申し上げます。

Ante-MS-P 265-40 D (\*\*PUF=PolyUrethaneForm)

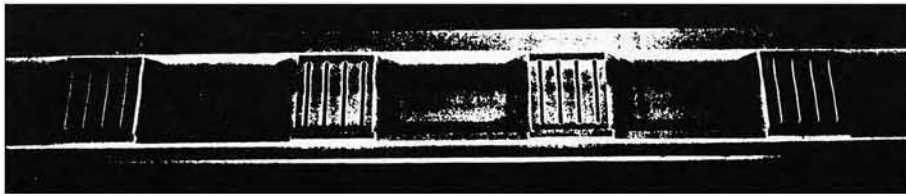

L = 3100

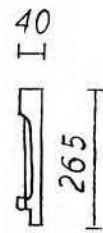

Ante-MS-P 80-25 D (\*\*PUF)



L = 2700



Ante-MS-P 100-80 D (\*\*PUF)

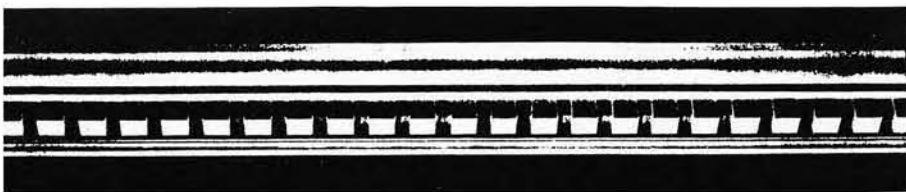

L = 3600

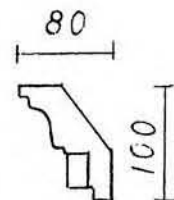

Ante-MS-P 60-60 D (\*\*PUF)

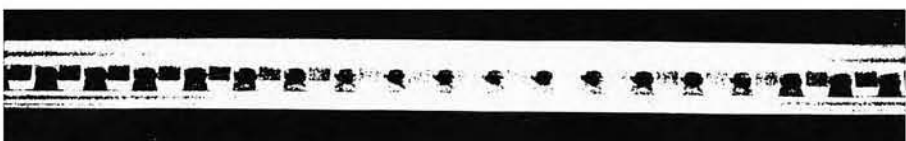

L = 3600

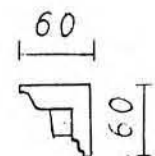

※各種 寸法調整加工承ります。



## Ante-MS-P 140-120 D

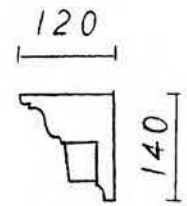
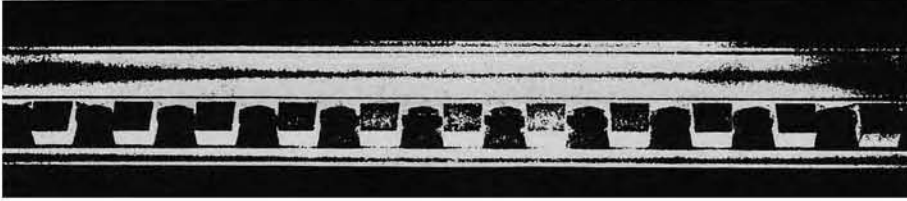

$L = 3000$

## Ante-MS-P 155-75 D

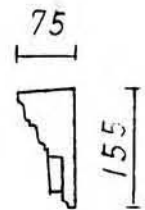
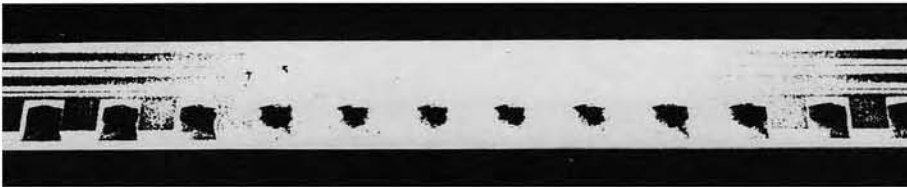

$L = 3600$

## Ante-MS-P 242-35 D

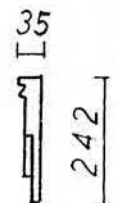

$L = 3600$

※各種 寸法調整加工承ります。

# Moldings

# Polyurethane

Ante-MS-P 120-50(\*\*PUF)

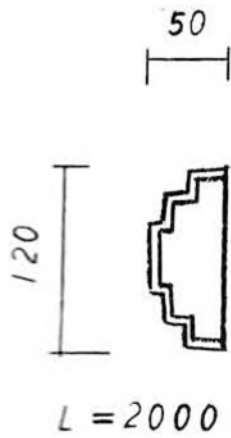

Ante-MS-P 130-20(\*\*PUF)

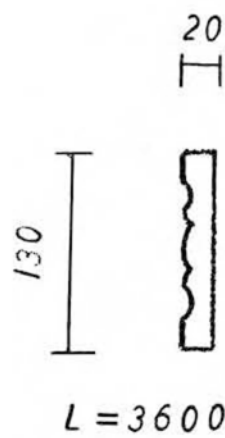

Ante-MS-P 140-45(\*\*PUF)

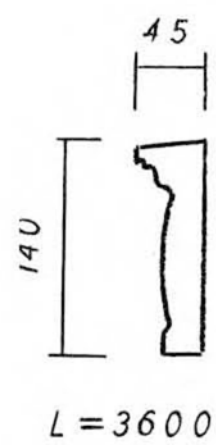

Ante-MS-P 120-80(\*\*PUF)



Ante-MS-P 200-30(\*\*PUF)

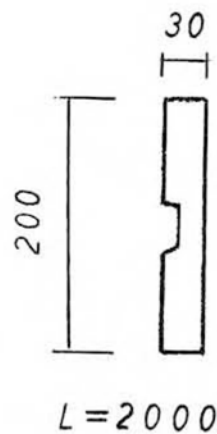

Ante-MS-P 210-100(\*\*PUF)

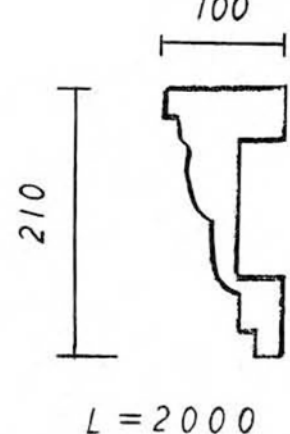

Ante-MS-P 130-100(\*\*PUF)

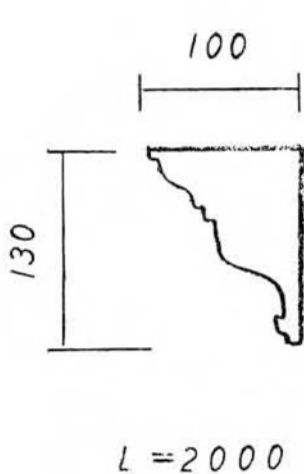

Ante-MS-P 135-75(\*\*PUF)

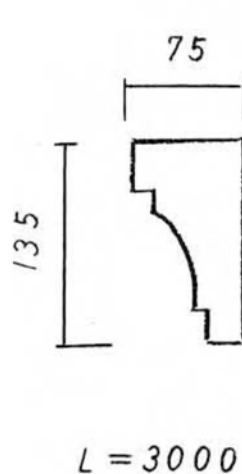

Ante-MS-P 75-25(\*\*PUF)

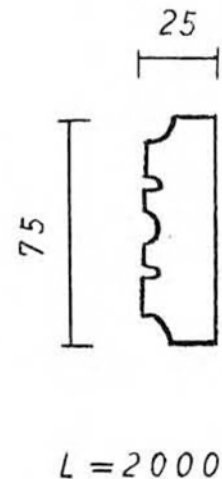

※各種 寸法調整加工承ります。

Ante-MS-P 45-30(\*\*PUF)

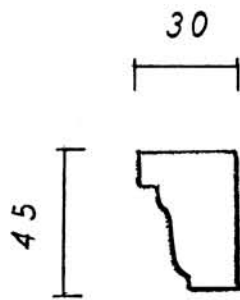

L = 3000

Ante-MS-P 60-30(\*\*PUF)

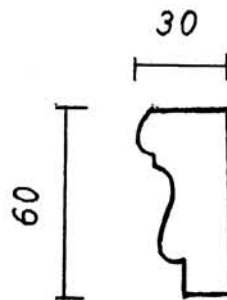

L = 3000

Ante-MS-P 60-37(\*\*PUF)

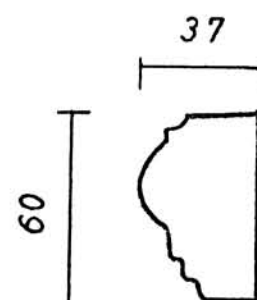

L = 2000

Ante-MS-P 65-50 A (\*\*PUF)

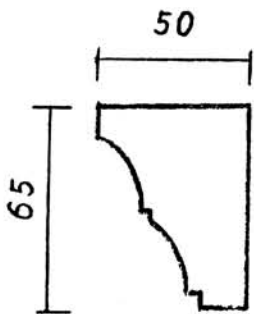

L = 3600

Ante-MS-P 65-50 B (\*\*PUF)

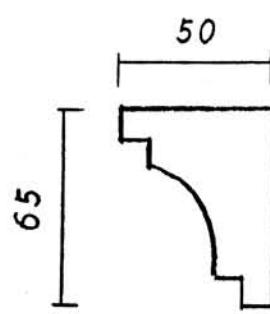

L = 2000

Ante-MS-P 72-62(\*\*PUF)

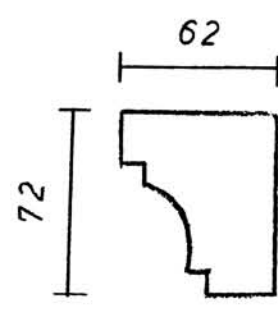

L = 3600

Ante-MS-P 80-30(\*\*PUF)

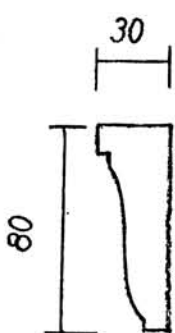

L = 3000

Ante-MS-P 90-40(\*\*PUF)

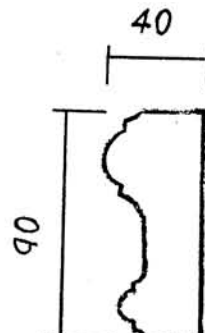

L = 2000

Ante-MS-P 100-20(\*\*PUF)

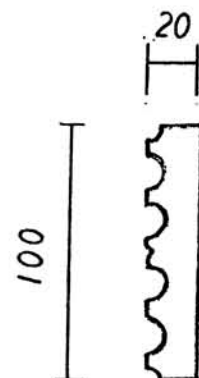

L = 2000

※各種 寸法調整加工承ります。

## Ante-FBS 80-15 / 115-15 / 120-25

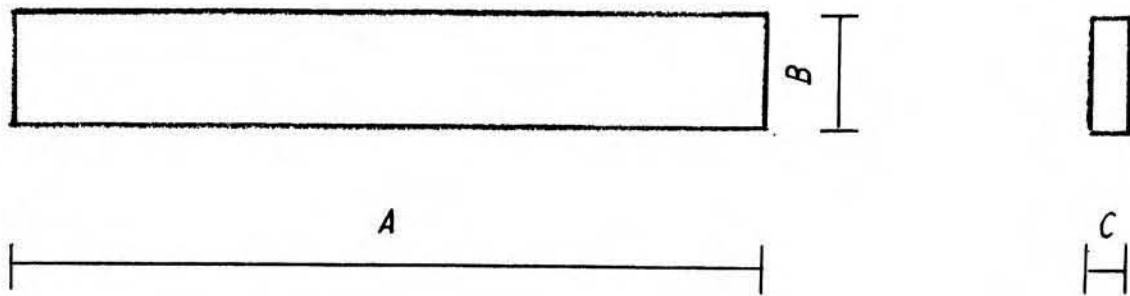

	A	B	C
Ante-FBS 80-15	3600	80	15
Ante-FBD 115-15	3600	115	15
Ante-FBS 120-25	3600	120	15

## Ante-FBS 80-50

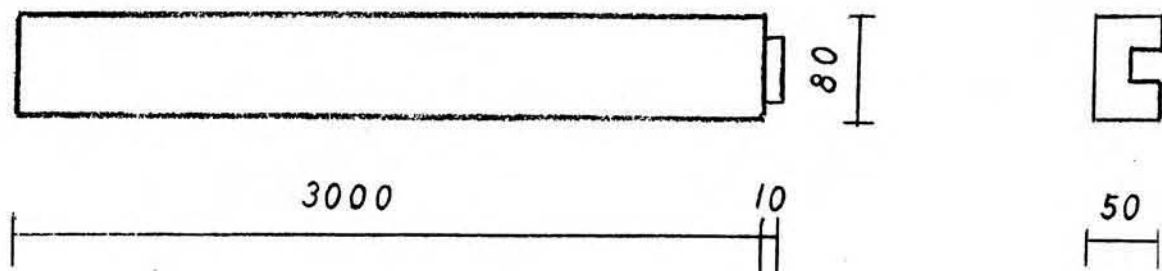

## Ante-FBS 180-50

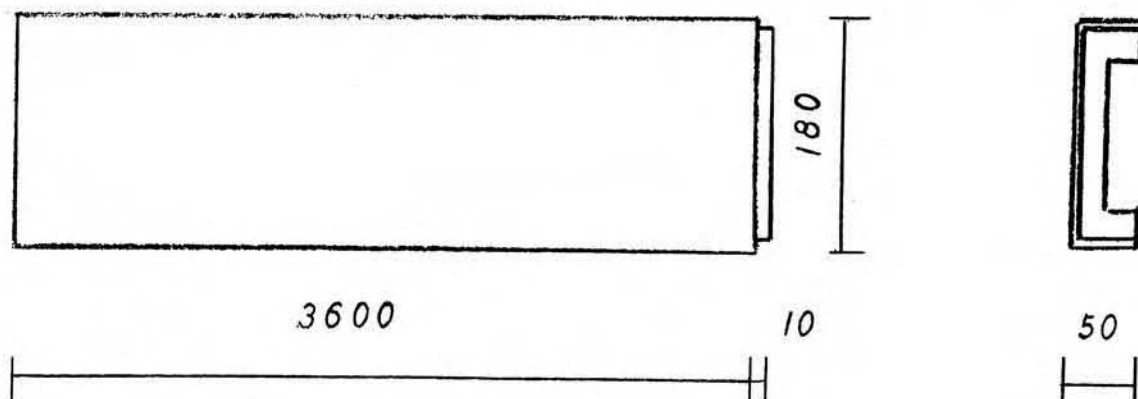

※各種 寸法調整加工承ります。

Ante-E-PS-F 001(\*\*FRP)

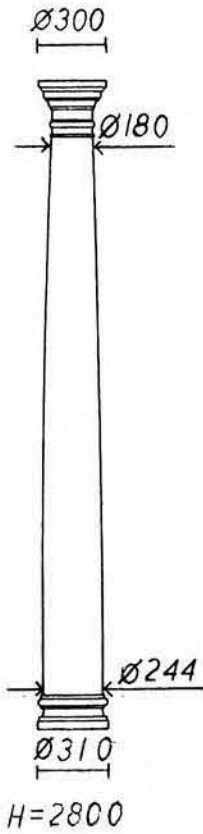

Ante-E-PS-F 002(\*\*FRP)

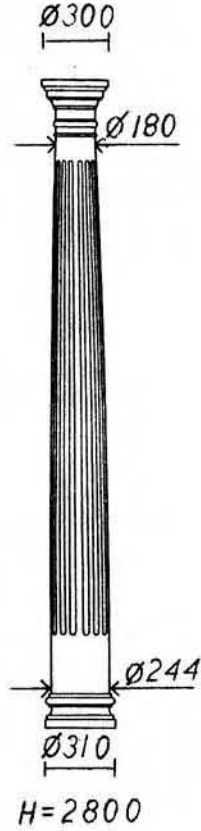

Ante-E-PS-F 003(\*\*FRP)

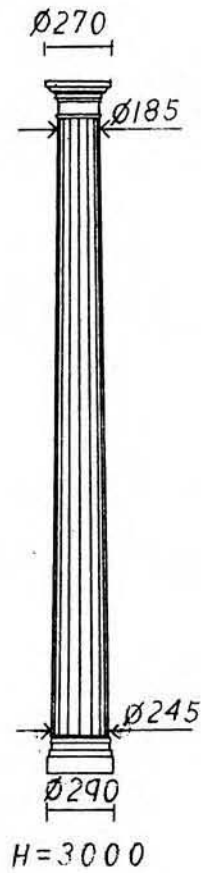

Ante-C-PS-F 250(\*\*FRP)

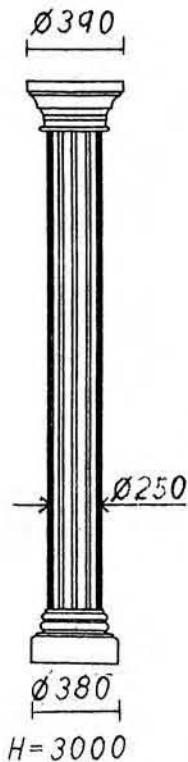

Ante-C-PS-F 200(\*\*FRP)

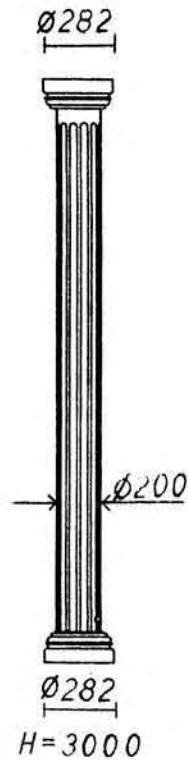

Ante-C-PS-F 175(\*\*FRP)

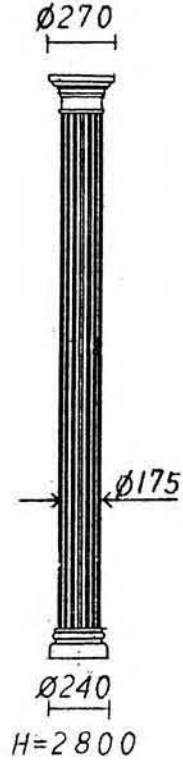

※各種 寸法調整加工承ります。